

Front Mount Conv.

Case IH

MX

215,245,275,305

Magnum

180,190,210,215,225

245,275,305,335

PARTS LIST			
ITEM	QTY	PART NUMBER	DESCRIPTION
1	1	20-1601R	Case MX FM Tank Bracket R
2	1	20-1601L	Case MX FM Tank Bracket L
3	1	20-1707L	MX 215,245,275,305 Side Brace L
4	1	20-1707R	MX 215,245,275,305 Side Brace R

Price List
\$1006.00

Limitations may apply. Please consult API Sales at 800-288-1117.

Bolt List		
QTY	Description	Placement
10	20 mm x 60 mm Bolts	Saddle Brackets to Tractor
8	20 mm x 45 mm Bolts	Side Brace to Tractor
18	20 mm Harden Flatwashers	
6	3/4 x 2 1/2 Bolts	Front Bracket to Side Brace
6	3/4 in Lock Washers	
6	3/4 in Nuts	

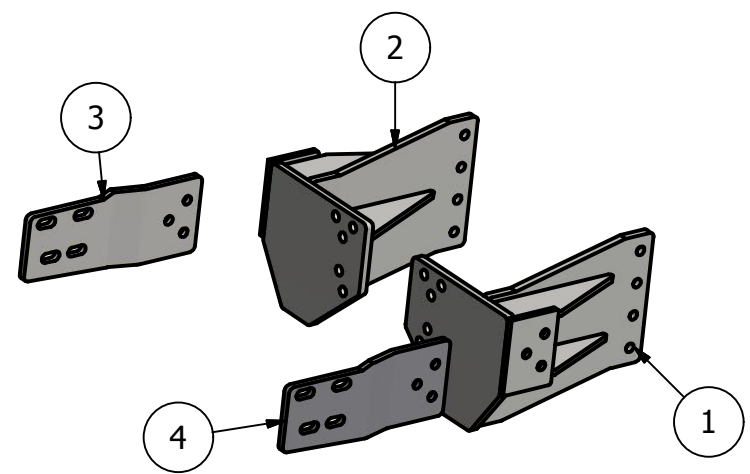

Conv ID: CS-MAGMX-0611-FM-CONV