

# Front Mount Conv. Case IH Magnum

7110,7120,7130,7140,7150  
7210,7220,7230,7240,7250

PARTS LIST			
ITEM	QTY	PART NUMBER	DESCRIPTION
1	1	20-1302	Magnum 71/72 Hook
2	1	20-1706R	Case Mag 71/72 FM Side Brace R
3	1	20-1706L	Case MAG 71/72 FM Side Brace L

Price List  
\$915.00

Limitations may apply. Please consult API  
Sales at 800-288-1117.

Bolt List		
QTY	Description	Placement
8	3/4 x 2 1/2 Bolts	Hook to Saddle
6	3/4 x 2 1/2 Bolts	Side Brace to Hook
8	16 mm x 60 mm Bolts	Side Brace to Tractor
14	3/4 in Lock Washers	
14	3/4 in Nuts	
8	16 mm Harden Flatwashers	

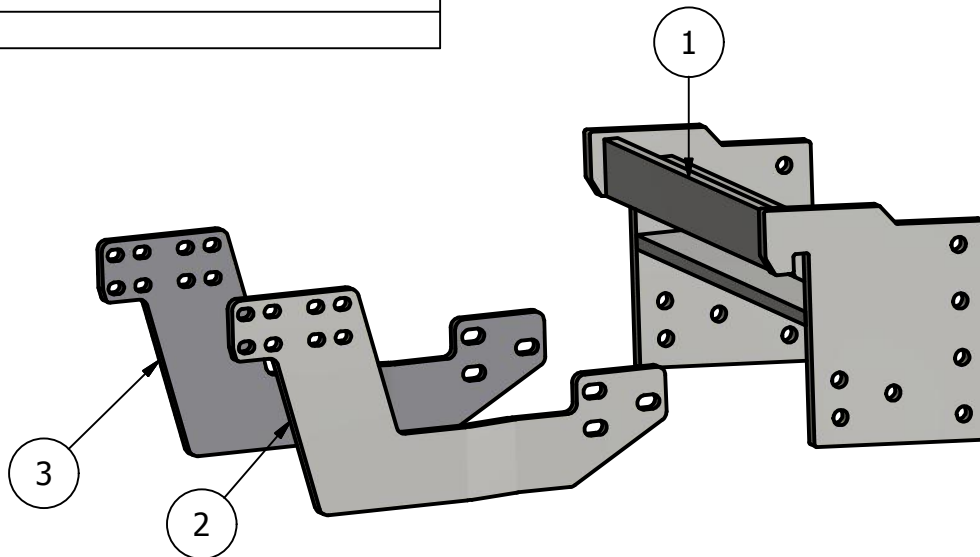

Conv ID: CS-MAG7189-8796-FM-CONV