

Front Mount Case IH Magnum

8910,8920,8930,8940,8950

PARTS LIST

ITEM	QTY	PART NUMBER	DESCRIPTION
1	1	20-1301	Case MAG 89 Hook
2	1	20-1705R	Case MAG 89 FM Side Brace R
3	1	20-1705L	Case MAG 89 FM Side Brace L
4	1	20-1011	300 Saddle

Price List
300 gal w/Tank \$2575.00

Limitations may apply. Please consult API
Sales at 800-288-1117.

Bolt List

QTY	Description	Placement
4	3/4 x 2 1/2 Bolts	Hook to Saddle
4	3/4 x 3 1/2 Bolts	Side Brace to Hook
6	16 mm x 60 mm Bolts	Side Brace to Tractor
8	3/4 in Lock Washers	
8	3/4 in Nuts	
6	16 mm Harden Flatwashers	
2	Nylon Straps	

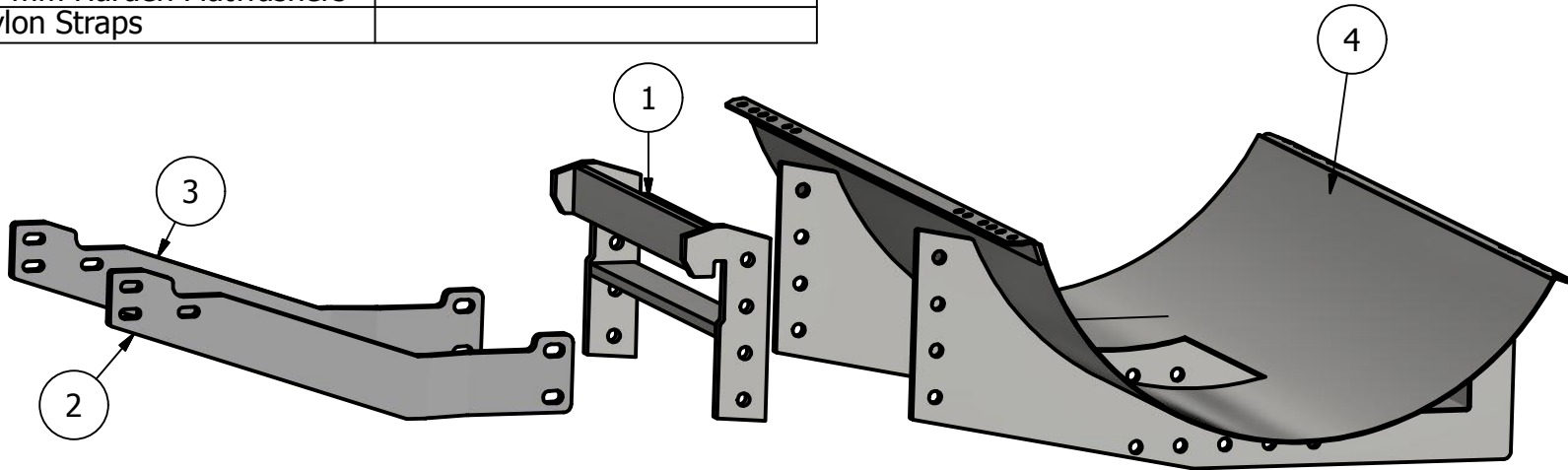

300 ID: CS-MAG7189-9798-FM-300R