

Side Mount Dual Case IH MX Series

180,200,220,240,270 (1999-2002)
210,230,255,285 (2003-2005)
215,245,275,305 (2006-2007)

Magnum

215,245,275,305,335 (2008-2011)

Bolt List

QTY	Description	Placement
12	20 mm x 90 mm Bolts	Side Plate to Tractor
2	20 mm x 110 mm Bolts	Step to Side Plates to Tractor
14	20 mm Harden Flatwashers	
4	3/4 x 2 1/2 Bolts	Side Plates to Undertruss
28	1 x 2 1/2 Gd 8 Bolts	Side plate to Tube
12	1 x 3 Gd 8 Bolts	Side Plate to Tube
40	1 in Lock Washers	
40	1 in Nuts	
4	3/4 x 7 x 9 U Bolts	Conv to Tube
12	3/4 x 2 1/2 Bolts	Saddle to Conv
16	3/4 in Lock Washers	
16	3/4 in Nuts	
4	Nylon Straps	Tank to Saddle

PARTS LIST

ITEM	QTY	PART NUMBER	DESCRIPTION
1	1	20-1414 L	Case MX New Style Side Plate L
2	1	20-1205	Case MX Undertruss New style
3	1	20-1414 R	Case MX New Style Side Plate R
4	2	20-1029	Extended Dual Tube 12-2012
5	2	20-1800	Saddle Conv.
6	2	20-1011	300 Saddle
7	2	20-1013	400 Saddle

Price List

High Clearance w/Front Duals
300 gal w/Tanks \$7672.00
400 gal w/Tanks \$8255.00

Limitations may apply. Please
consult API Sales at 800-288-1117.

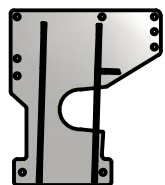

FRONT

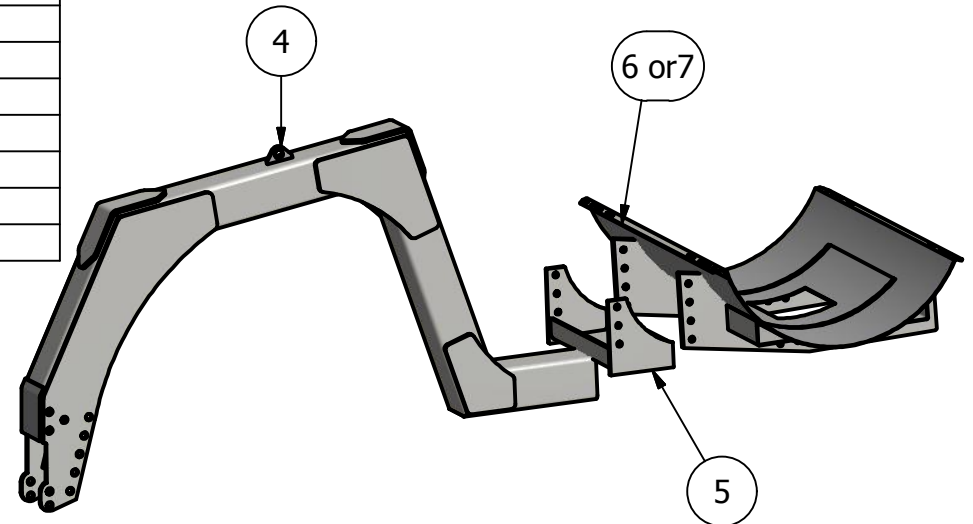
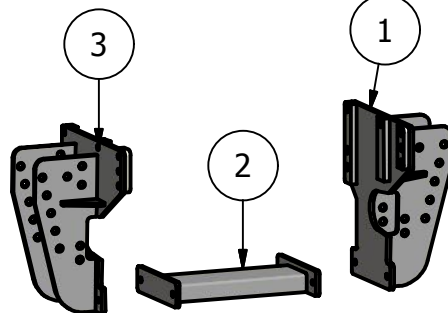

300 ID: CS-MAGMX-9911-SMD-300R
400 ID: CS-MAGMX-9911-SMD-400R