

Side Mount Case IH Puma 165,180,195,210

PARTS LIST			
ITEM	QTY	PART NUMBER	DESCRIPTION
1	1	20-1409L	Case Puma 180 Side Plate L
2	1	20-1409R	Case Puma 180 Side Plate R
3	1	20-1206	Case Puma 180 Undertruss
4	2	20-1022	7x7x6' tube, black
5	2	20-1800	Saddle Conv.
6	2	20-1011	300 Saddle
7	1	30-1903	Step bottom Bracket
8	1	30-1902	Step Handle

Bolt List		
QTY	Description	Placement
4	20 mm x 110 mm Bolts	Side Plate to Tractor
6	20 mm x 75 mm Bolts	Side Plates to Tractor
10	20 mm Harden Flatwashers	
10	20 mm Nuts	
24	3/4 x 2 1/2 Bolts	Side Plates to Undertruss
20	3/4 x 2 1/2 Bolts	Side plate to Tube
4	3/4 x 7 x 9 U Bolts	Conv to Tube
12	3/4 x 2 1/2 Bolts	Saddle to Conv
64	3/4 in Lock Washers	
64	3/4 in Nuts	
4	Nylon Straps	Tank to Saddle

Price List
\$4900.00

Limitations may apply. Please consult API Sales at 800-288-1117.

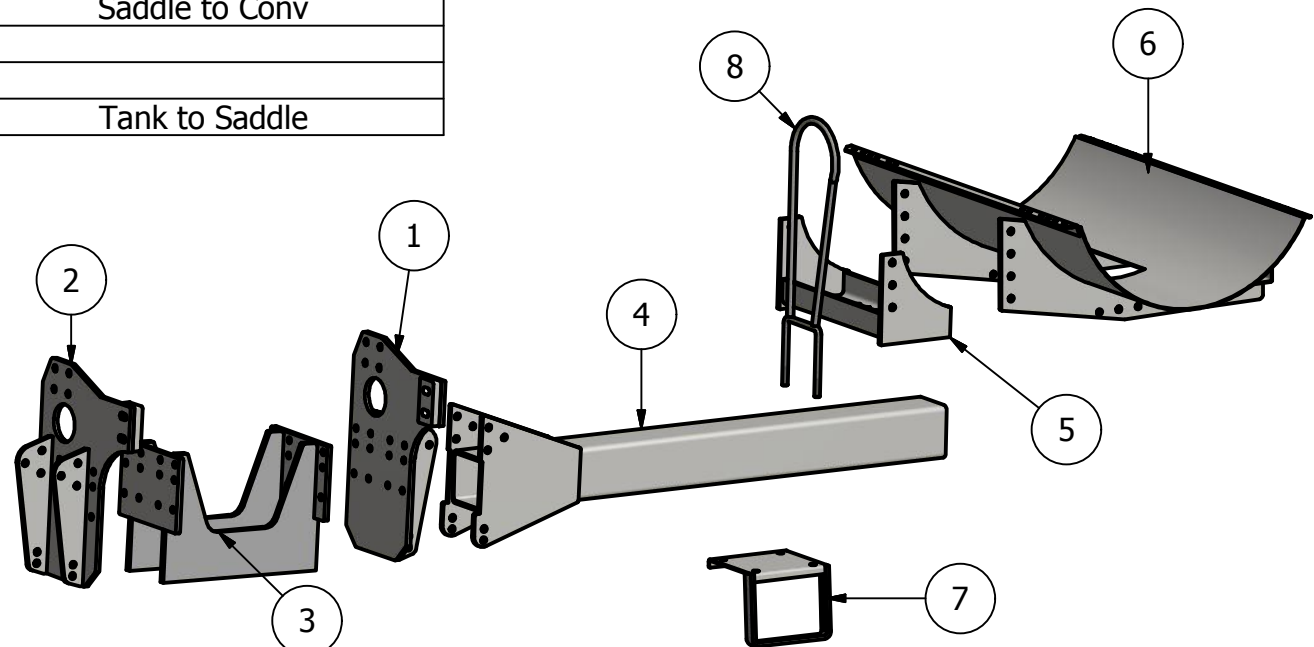

300 ID: CS-PUMA-0710-SMS-300R