

Front Mount CAT Challenger

MT635,MT645,MT655,MT665

PARTS LIST			
ITEM	QTY	PART NUMBER	DESCRIPTION
1	1	30-1301	Agco Allis Hook
2	1	30-1701L	Cat MT a FM Brace L
3	1	30-1701R	Cat MT a FM Brace R
4	1	20-1011	300 Saddle
5	1	20-1012E	300 Ellip Saddle
6	1	20-1013	400 Saddle

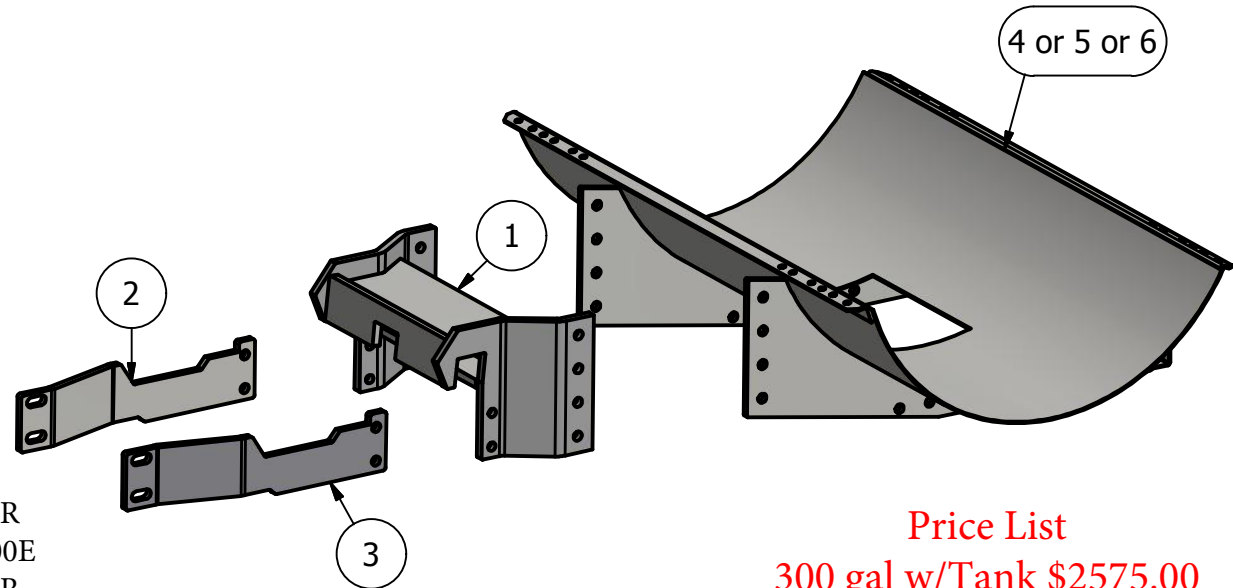

300 ID: AMC-DTAMT600-0208-FM-300R
 300E ID: AMC-DTAMT600-0208-FM-300E
 400 ID: AMC-DTAMT600-0208-FM-400R

Price List
 300 gal w/Tank \$2575.00
 300 gal Elliptical w/Tank \$2884.00
 400 gal w/Tank \$2924.00

Bolt List		
QTY	Description	Placement
4	16 mm x 75 mm Bolts	Side brace to Tractor
12	3/4 x 2 1/2 Bolts	Tractor Brackets to Saddle
4	16 mm Hardened Flatwashers	
12	3/4" Lockwashers	
12	3/4" Nuts	
2	Nylon Straps	Tank to Saddle

Limitations may apply. Please
 consult API Sales at
 800-288-1117.